

Development of a Real Time Axial Force Measurement System and IoT-Based Monitoring for Smart Bearing

Hassam Ahmed, Yuanzhi Liu, Yassine Selami, Wei Tao, Hui Zhao

Abstract—The purpose of this research is to develop a real time axial force measurement system for a smart bearing through the use of strain-gauges, whereby the data acquisition is performed by an Arduino microcontroller due to its easy manipulation and low-cost. The measured signal is acquired and then discretized using a Wheatstone Bridge and an Analog-Digital Converter (ADC) respectively. For bearing monitoring, a real time monitoring system based on Internet of things (IoT) and Bluetooth were developed. Experimental tests were performed on a bearing within a force range up to 600 kN. The experimental results show that there is a proportional linear relationship between the applied force and the output voltage, and the error R squared is within 0.9878 based on the regression analysis.

Keywords—Bearing, force measurement, IoT, strain gauge.

I. INTRODUCTION

BEARINGS are an integral part of a mechanical system that translates rotary and linear motion with minimal friction. Bearings are mostly applied in rough environments such as the automotive, aerospace, railway, and manufacturing industries; thus, the chances of bearing failure are great. Failure of a bearing can cause major breakdowns in industrial machinery [1]. Such failures have been accountable for more substantial machine inoperability. In extreme operating environments that involve heavy loads, high speeds and temperatures, premature bearing failure is most probable [2]. A condition monitoring system is required to monitor health status of bearings so as to help avoid such failures. It involves developing a widely utilized system that offers maintenance cost optimization while providing high levels of safety [3]. Bearings require effective condition monitoring that is designed to detect bearing breakdowns. A system that utilizes early detection methods can minimize risks associated with machine and mechanical failure. Research papers are constantly being published consisting of literature reviews on this topic that focus on designing systems for monitoring of bearings. In [4]-[7], authors have worked on vibration signals for bearing monitoring. In [8], a temperature sensor is designed for health monitoring of bearings. In [9], fuzzy logic

and sound analysis is done for condition monitoring of bearings. Simultaneously, the temperature of bearing cage and its vibration was measured by [10], using inductive coupling for monitoring purposes.

Excessive load is one of the main causes of failure/damage of bearings which has been surprisingly neglected by many researchers in the monitoring systems of bearings. The loading of a bearing is the ratio of the applied force to the cross-sectional area of the bearing. As we know, that area of the bearing remains the same, making increased force the cause of excessive load. In this project, in order to find a solution to this problem, a force measurement sensor was designed for bearings using strain gauge. Strain gauge is commonly used in various fields such as automobile, chemical, civil engineering construction and machinery, as well as in laboratory experiments. It is used for measuring force, acceleration, torque, loads, displacement and pressure. It typically consists of metal as the transducer body and strain gauges as sensing elements to detect strain in the transducer body. Strain gauge can detect minute contraction and elongation of a structure [11].

Force is an important factor for monitoring of machines; in many cases, excessive force is responsible for damage to machines. In early studies, it has been concluded that excessive force was one of the main cause of bearing failure [12]. Designing a force measurement sensor for bearings was quite challenging. Our task was to find an appropriate location for mounting strain gauge, designing a circuit which measured and transferred micro volts of strain gauge to a microcontroller and converted that volt value to force by coding and finally transmitting that data to an IoT Cloud and android application.

The IoT is a cloud based application to monitor and control systems; Bluetooth facilitates wireless data transmission up to 100 meters. In project, Wi-Fi and Bluetooth module were connected with IoT system and Bluetooth via Arduino. For real-time monitoring of force, a Bluetooth module transmits measured force value to Android application. It offers live monitoring of the force on bearings each second from the field whereas, Wi-Fi module transmits sensor signals to IoT Cloud, which allows to monitor data from anywhere & anytime in the globe.

II. THEORY

A. Principle of Strain Gauge

Every metal has a particular resistance of its own. If an

Hassam Ahmed, Yuanzhi Liu, Yassine Selami is with the Department of Instrument Science and Technology, Shanghai Jiao Tong University, China (e-mail: hassamahmed@sjtu.edu.cn, lyzrose@sjtu.edu.cn, selami.yassine@gmail.com).

Wei Tao and Hui Zhao* are working as Professor in Department of Instrument Science and Technology, Shanghai Jiao Tong University, China (*Corresponding author; e-mail: taowei@sjtu.edu.cn, huizhao@sjtu.edu.cn).

external force is applied, its resistance will increase or decrease proportionally depending on the type of force applied. If the original resistance R changes by ΔR because of strain ϵ , the following equation is derived:

$$\frac{\Delta R}{R} = K_s \cdot \epsilon \quad (1)$$

where K_s is a gauge factor, expressing the sensitivity coefficient of strain gauge [13]. Generally, strain gauge's resistive element is made up of copper-nickel alloy, and the gauge factor of this alloy is approximately 2 [14].

B. Strain Measurement

Extremely small resistances change when tensile force or compression force is applied on strain gauge. To measure these small changes in resistance, a Wheatstone bridge is required to convert resistance into voltage which helps us to measure strain precisely. If strain gauge resistances identified as R_1 , R_2 , R_3 and R_4 in Fig. 1 show bridge voltage determined as E , then output voltage e_o can be obtained using [15]:

$$e_o = \frac{R_1 R_3 - R_2 R_4}{(R_1 + R_2)(R_3 + R_4)} \cdot E \quad (2)$$

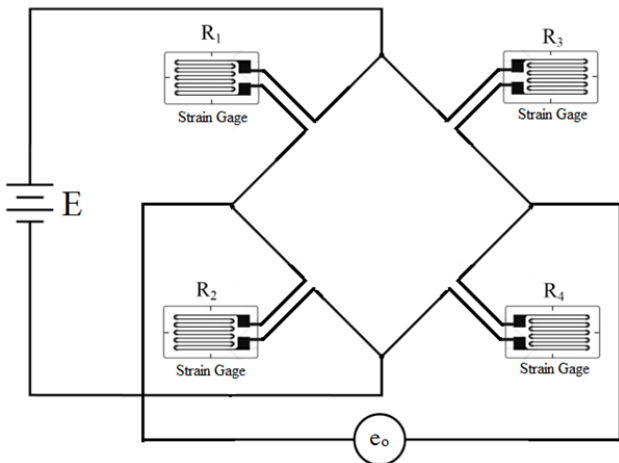

Fig. 1 Strain gauge connection

C. Wheatstone Bridge

If small variations occur in the resistive sensor, it will be necessary to use supplementary circuits with the sensor in order to get good sensitivity. The Wheatstone bridge circuit is required where the resistance variations of the strain gauges are minimal. By using such circuit, unknown resistance can be measured through the balance of the circuit. This will allow us to measure resistance with great precision.

III. EXPERIMENTAL WORK

A. System Design

To design the entire system, 4 strain gauges, a microcontroller ADS1256, a Wi-Fi module ESP8266, Bluetooth module HC-05 and power bank were used. The 4-gauge Wheatstone bridge configuration was chosen in order to

have good sensitivity due to its capability to detect strains in lateral and longitudinal directions and to minimize the effect of temperature on the results. The output voltage signal from the Wheatstone bridge was amplified by using ADS1256 and processed in the microcontroller to transmit the data (Wi-Fi and Bluetooth modules were used with the microcontroller). To power up the complete system, a power bank was used. Fig. 2 illustrates the block diagram of this project.

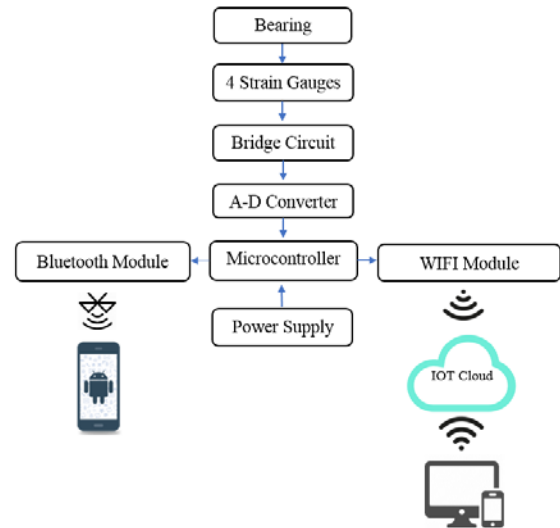

Fig. 2 Block diagram of project

1) Strain Gauge Bonding

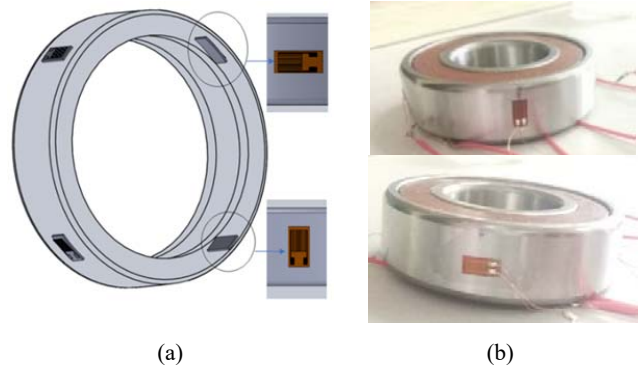

Fig. 3 Installation of strain gauge on: (a) 3D model (b) Small sized bearing

Strain gauge installation was done according to the bonding procedure recommended by the strain gauge's manufacturer. Installation procedure is described as follow: Initially the surface must be sanded carefully where the strain gauge will be glued. Next, the surface should be cleaned with acetone or alcohol and this surface must be marked after cleaning. The bonding process then occurs which requires transparent tape, a glass base, tweezers and glue. The first step to bonding is to glue the strain gauge on the glass base with the transparent tape. When the tape is removed from the glass base, the strain gauge must be removed along with the tape still attached. This step facilitates bonding the strain gauge in the correct position on the surface where the deformation is to be measured. After

this, the tape has to be carefully removed so as to position the strain gauge properly onto the surface which was marked previously. A small amount of glue is then inserted underneath the strain gauge with tape repositioned and pressed firmly for adherence and to smooth out any bubbles. Once the cure time of the adhesive has elapsed, the tape is then carefully removed. Fig. 3 (a) shows position of strain gauges on 3D model and Fig. 3 (b) shows the installation of the strain gauges on the surface of a small sized bearing.

2) Electronic Circuit

In this project Arduino is used because it is easily available and there are many modules which are supported by Arduino. It is easy to program and it has many pins to read analog and digital signals. The Wheatstone bridge circuit implemented was powered by Arduino voltage while the output signal of the circuit was connected to ADS1256 where discretization and amplification of the output signal were performed. An external Analog Digital Converter (ADS1256) was used because the resolution of most Arduino microcontrollers are 12 bits, thus the output signal is needed to be amplified more. After amplification, the signals were converted into force by using a best fit line equation which can be easily done on Arduino by coding. To transmit this force value to the android mobile application and to an IoT platform known as ThingSpeak, Bluetooth and Wi-Fi modules were used respectively.

B. Force Measurement Setup

Initially, a bearing model was designed and strain simulation was performed using SolidWorks. In the simulation, force was applied from one side of the bearing while the other side was fixed. Simulation results illustrated the strain value on different parts of the bearing as shown in Fig. 4.

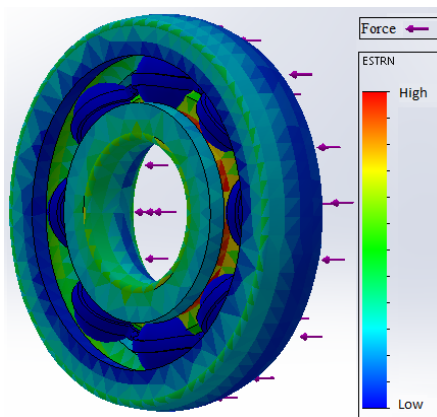

Fig. 4 Strain simulation

The static calibration was performed on two different sizes of bearings. On the smaller sized bearing, force was applied using a small force compression machine as shown in Fig. 5, from 0 kN to 110 kN. Force interval was random between these ranges. The voltage output from the bridge circuit was measured using a multimeter and noted. Using the data, a

graph between applied force and measured voltage was plotted in Fig. 8.



Fig. 5 Small force compression machine

On the industrial-sized bearing, the same calibration was performed, however this time using an industrial-force compression machine as shown in Fig. 6. Here the force was increased from 300 kN to 600 kN with an interval of 20 kN. The force was then decreased from 600 kN to 300 kN with a 20 kN interval. Both sets of data were noted and a graph was plotted between the applied force and measured voltage as seen in Fig. 9.



Fig. 6 Industrial force compression machine

C. Data Processing and Transmission

Initially to read data from ADS1256 amplifier, the library is imported then by using best fit line equation of graph, the data are converted into force. The microcontroller will check to see whether Bluetooth is connected or not. After confirmation, the force value will be transmitted to the android application which is designed to get data via Bluetooth and displayed the force value on the mobile application. The system is not fully dependent on Bluetooth; therefore, it will check for internet

connection by using Wi-Fi module. If it is connected the data will be transmitted to ThinkSpeak which is IoT platform, where force data could be seen graphically and made accessible to anyone anywhere around the world via the internet. If Wi-Fi and Bluetooth both had not been connected, then the system would keep checking until one of them connects. In the end, the delay function is used so that the next transmitted data could be read after some interval. This loop works continuously and keeps transmitting data. A project flowchart as shown in Fig. 7 illustrates this complete system of coding.

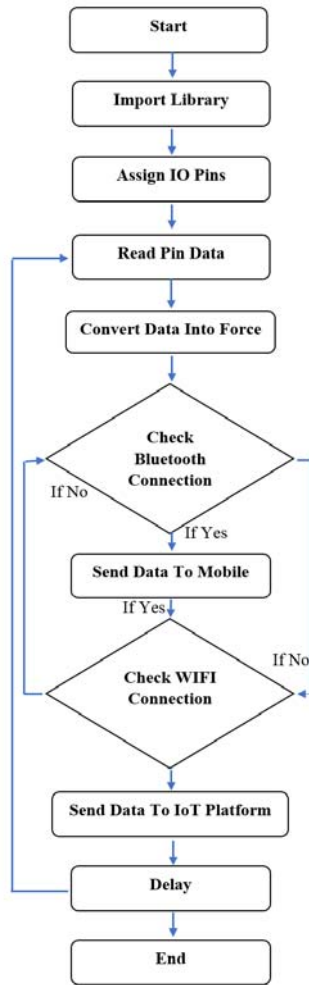

Fig. 7 Project flowchart

IV. RESULTS AND DISCUSSION

Data were plotted between the applied force and measured voltage, as displayed by Fig. 8 which shows the linearity proportional to the applied load. As can be seen, almost a straight line can be drawn from the data plot which indicates that the force transducer gives accurate data if compared with the theory. A regression analysis of the dependent variable (voltage) and independent variable (force) confirms the proportionality. It has the regression equation as:

$$y = 0.0248x + 3.1708 \quad (3)$$

where y is output voltage (mV) and x is applied force (kN). The error R squared is 0.9893.

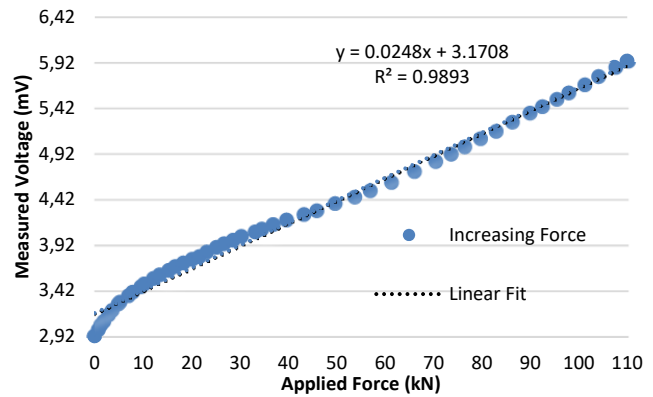

Fig. 8 Applied force vs. measured voltage (Small-sized bearing)

The same graph was plotted for the industrial bearing which showed the linearity proportional to the applied load and almost a straight line could be drawn from this data plot. This indicates that the force transducer gives accurate data if compared with the theory. A regression analysis of the dependent variable (voltage) and independent variable (force) confirms the proportionality. It has the regression equation as:

$$y = 0.0015x + 0.3294 \quad (4)$$

where y is output voltage (mV) and x is applied force (kN). The error R squared is 0.9878. It can be concluded that the voltage outputs can be used to predict the value of force being applied with small error.

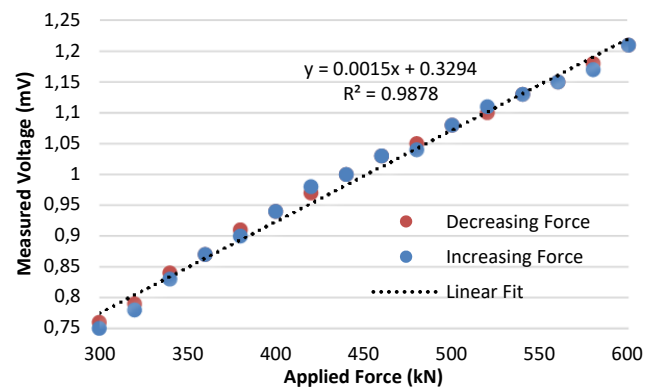

Fig. 9 Applied force vs. measured voltage (Industrial-sized bearing)

In the above results, a minute error can be observed due to the following reasons:

- 1) A minor inaccuracy in placement of strain gauge can cause error.
- 2) Strong bonding agent is required for accurate results.
- 3) Strain gauge bridge gives a lot of fluctuation.
- 4) The circuit noise can influence results.

The designed mobile application as shown in Fig. 10 was integrated with Arduino using Bluetooth technology to

constantly monitor force and analyze excessive bearing load.



Fig. 10 Mobile application

ThingSpeak IoT cloud platform collect force data from Arduino through internet and present them to the website at a delay of 15 seconds as shown in Fig. 11.

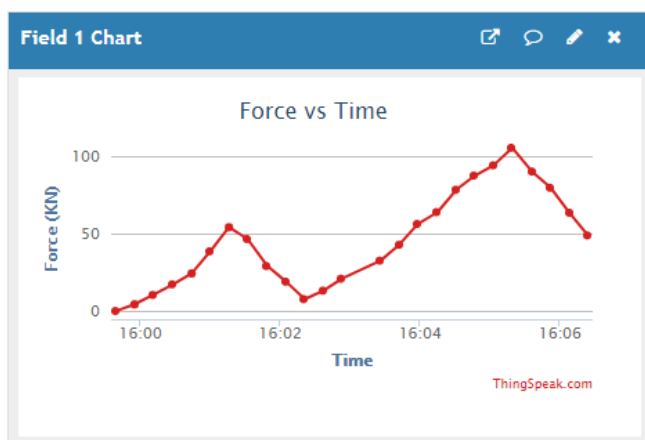

Fig. 11 ThingSpeak IoT cloud: Force vs time

V. CONCLUSION

This paper presented the design and implementation of a force monitoring system to measure the force applied on a bearing constantly being transmitted to 2 wireless platforms, namely Bluetooth and Wi-Fi. Bluetooth module transmitted output force data to android device, whereas, the Wi-Fi module transmitted data to an IoT platform over the internet which is accessible anytime and anywhere around the globe. The used hardware can easily integrate with its components and has been well documented in the literature [16]-[20]. Using strain gauge, force is measured and successfully tested up to 600 kN. Results from this experiment showed promising

performance. This study concluded that strain gauge is capable of withstanding high static loads without damage and has proven to be a more cost-effective sensor. Figs. 8 and 9 present the linear relationship between applied force and voltage with an insignificant error value for small and industrial sized bearing respectively. The error can be further improved by proper positioning installment of the strain gauge. Outcomes from this experiment clearly show that advance technology can be developed at a minimal cost while offering more benefits through integration.

The most challenging part of this project was trying to mount the strain gauge sensor precisely onto surfaces; this could be the main focus for further research. The experiment could be further extended by integrating additional sensing modalities with tailored sensor nodes customized to various monitoring system applications as needed. Developing a better web interface that offers more functionality and experience to the user can be a best way of moving forward as it will prove productive in providing better data visualization, management, and overall analysis.

REFERENCES

- [1] H. Martin, F. Honarvar, "Application of statistical moments to bearing failure detection," *Appl. Acoustics* 44 (1), 1995, pp. 67-77.
- [2] R.K. Upadhyay, L.A. Kumaraswamidhas, M.S. Azam, "Rolling element bearing failure analysis: a case study," in *Case Studies Engineering Failure Analysis* vol 1 issue 1, 2013, pp. 15-17.
- [3] V. Nistane, S. Harsha, "Failure evaluation of ball bearing for prognostics," *Proc. Technol.* 23, 2016, pp.179-186
- [4] Y. K. Chaudhari, J. A. Gaikwad, and J. V. Kulkarni, "Vibration analysis for bearing fault detection in electrical motors," in *Networks & Soft Computing (ICNSC)*, 2014 First International Conference on. IEEE, 2014, pp. 146-150.
- [5] Mao Kunli and Wu Yunxin, "Fault Diagnosis of Rolling Element Bearing Based on Vibration Frequency Analysis," in *Third International Conference on Measuring Technology and Mechatronics Automation*, 2011, pp. 198-201.
- [6] Jie Bian, Ping Wang, Qing Mei, and Mozhi Lei, "Fault Detection of Rolling Bearings through Vibration Analysis via the hybrid CEEMD-EMD Approach," in *Prognostics and System Health Management Conference*. 2014, pp. 245-250.
- [7] A. Boudiaf: S. Bouhouche, A. K. Moussaoui, and T. Smnira, "An effective method for bearing faults diagnosis," in *Control, Engineering and Information Technology (CEIT) IEEE*, 2015, pp. 1-6.
- [8] S. Scott, F. Sadeghi, and D. Peroulis, "An inherently-robust 300 °C MEMS temperature sensor for wireless health monitoring of ball and rolling element bearings," in *Proc. IEEE Sensors*, 2009, pp. 975-978.
- [9] Thitipan, Noreesuwan and Bandit Suksawat, "Propose of Unsealed Deep Groove Ball Bearing Condition Monitoring Using Sound Analysis and Fuzzy Logic," in *Proc. of International Conference on Control, Automation and Systems 2010 (ICCAS2010)*, 2010, pp.409-413.
- [10] A. Shahidi, L. A. Gupta, A. Kovacs, and D. Peroulis, "Wireless temperature and vibration sensor for real-time bearing condition monitoring," in *Proc. IEEE MTT-S Int. Microw. Symp. Dig. (IMS)*, Seattle, WA, USA, Jun. 2013, pp. 1-4
- [11] Permana, E and Yayat, "Design and Development of Impact Load Sensor for Dynamic Testing Purposes," in *IOP Conference Series: Materials Science and Engineering*, 2018, 288. 012060. 10.1088/1757-899X/288/1/012060.
- [12] Kyowa Electronic Instruments Co. Ltd., 2016 Introduction to Strain Gauges
- [13] Schulz, M., Song, Y., Hehr, A. and Shanov, V., "Embedded carbon nanotube thread piezoresistive strain sensor performance", *Sensor Review*, Vol. 34 No. 2, 2014, pp. 209-219.
- [14] Alan S M 1993 Principles of Measurement and Instrumentation Prentice Hall, London.
- [15] Alan S M 1993 Principles of Measurement and Instrumentation Prentice

Hall, London

- [16] R. S. Rosli, M. H. Habaebi and M. R. Islam, "Characteristic Analysis of Received Signal Strength Indicator from ESP8266 WiFi Transceiver Module," in *2018 7th International Conference on Computer and Communication Engineering (ICCCCE)*, Kuala Lumpur, 2018, pp. 504-507
- [17] A. Cotta and N. T. Devidas, "Wireless Communication Using Hc-05 Bluetooth Module Interfaced with Arduino," in *International Journal of Science, Engineering and Technology Research (IJSETR)*, 2016, pp. 869-872
- [18] V. Oza and P. Mehta, "Arduino Robotic Hand: Survey Paper," in *2018 International Conference on Smart City and Emerging Technology (ICSCET)*, Mumbai, 2018, pp. 1-5
- [19] "ADS1256 24-Bit, 30kSPS, 8-Ch Delta-Sigma ADC with PGA for Factory Automation and Process Control." (Online). Available: <http://www.ti.com/product/ADS1256>
- [20] Tutak Piotr, "Application Of Strain Gauges In Measurements Of Strain Distribution In Complex Objects," in *Journal of Applied Computer Science Methods*, 2014, pp. 135-145