

Gravitational Search Algorithm (GSA) Optimized SSSC Based Facts Controller to Improve Power System Oscillation Stability

Gayadhar Panda, P. K. Rautraya

Abstract—Damping of inter-area electromechanical oscillations is one of the major challenges to the electric power system operators. This paper presents Gravitational Search Algorithm (GSA) for tuning Static Synchronous Series Compensator (SSSC) based damping controller to improve power system oscillation stability. In the proposed algorithm, the searcher agents are a collection of masses which interact with each other based on the Newtonian gravity and the laws of motion. The effectiveness of the scheme in damping power system oscillations during system faults at different loading conditions is demonstrated through time-domain simulation.

Keywords—FACTS, Damping controller design, Gravitational search algorithm (GSA), Power system oscillations, Single-machine infinite Bus power system, SSSC.

I. INTRODUCTION

RECENTLY, the deregulated energy market and the increasing demand of electricity have led to the expansion of power systems. This raised the problem of poorly damped inter-area electromechanical oscillations. In the past three decades, power system stabilizers (PSSs) have been extensively used to enhance the system damping for low frequency oscillation. However, there have been problems experienced over the years of operation. Some of these were due to the limited capability of PSS in damping only local and not inter-area modes of oscillations. In addition, the tuning of PSS is in some way not flexible and therefore sometimes they are not able to cope with changes in the power system structure. To avoid such problems, it has necessitated a review of the traditional power system concepts and practices to achieve a large stability margin, greater operating flexibility and better utilization of existing power systems. Recent development of power electronics introduces the use of Flexible AC Transmission Systems (FACTS) controllers in power systems. FACTS controllers are capable of controlling the network condition in a very fast manner and this unique feature of FACTS can be exploited to improve the stability of a power system. The detailed explanation about the FACTS controllers are well documented in the literature and can be found in [1], [2].

Gayadhar Panda is with the Dept. of Electrical & Electronics Engineering, NIT Meghalaya, India (e-mail: p_gayadhar@gmail.com).

P. K. Rautraya is with the Dept. of Electrical Engineering, Government College of Engineering, Kalahandi, Odisha, India (e-mail: pkrautraya@rediffmail.com).

FACTS controllers can be categorized into three major groups: Shunt devices such as the Static Synchronous Compensator (STATCOM), series devices such as the Static Synchronous Series Compensator (SSSC) and series-shunt devices such as the Unified Power Flow Controller (UPFC). Static Synchronous Series Compensator (SSSC) is one of the important members of FACTS family which can be installed in series with the transmission lines. SSSC is very effective in controlling power flow in a transmission line with the capability to change its reactance characteristic from capacitive to inductive. SSSC has become an effective tool for power flow control [3].

This paper investigates the static synchronous series compensator (SSSC) FACTS controller performance in terms of stability improvements. It consists of a solid state voltage source converter (VSC) which generates a controllable voltage at fundamental frequency. When the injected voltage is kept in quadrature with the line current, it can emulate as inductive or capacitive reactance so as to influence the power flow through the transmission line [4], [5].

The power system is a highly nonlinear system that operates in a constantly changing environment: loads, generator outputs, topology and key operating parameters change continually. When subjected to a transient disturbance, the stability of the system depends on the nature of the disturbance as well as the initial operating conditions. The system must be able to operate satisfactorily under these conditions and successfully meet the load demand. To improve the voltage stability and the damping of oscillations in power systems, supplementary control laws can be applied to existing devices. Moreover, a SSSC with a suitably designed external damping controller can be used to improve the damping of the low frequency power oscillations in a power network. The objective of control design exercise is to ensure adequate damping under all credible operating conditions. A conventional lead-lag controller structure is preferred by the power system utilities because of the ease of on-line tuning and also lack of assurance of the stability by some adaptive or variable structure techniques [6]-[8].

The problem of FACTS controller parameter tuning is a complex exercise. Recently, many researchers have investigated the use of artificial intelligence-based approaches to design a FACTS-based supplementary damping controller. These approaches include particle swarm optimization [9], [10], real coded genetic algorithm [11], differential evolution [12], multi-objective evolutionary algorithm [13]. Recently,

Gravitational Search Algorithm (GSA) technique appeared as a promising optimization algorithm for handling optimization problems. The gravitational search algorithm (GSA) is one of the newest stochastic search algorithm developed by Rashedi et al. [14]. This algorithm, which is based on Newtonian laws of gravity and mass interaction, has great potential to be a break-through optimization method. The most substantial feature of GSA is that gravitational constant adjusts the accuracy of the search, so it is to speed up solution process. Furthermore, GSA is memory less; it works efficiently like the algorithms with memory [15]-[17].

In this paper, SSSC based damping controller employing a newly developed gravitational search algorithm (GSA) is used to improve the damping of single-machine infinite-bus power systems. The parameters of the proposed controller are tuned by using gravitational search algorithm (GSA). To show the robustness of the proposed design approach, simulation results are presented under various disturbance and faults for single-machine infinite-bus power system. The effectiveness and superiority of the proposed design approach is illustrated by comparing with existing approach.

This paper is organized as follows. The single-machine infinite-bus (SMIB) power system model is described in Section II. The SSSC based damping controller is discussed in Section III. Gravitational Search Algorithm (GSA) is presented in Section IV and in Section V; the tuning of damping controller parameters using GSA has been described. Simulation results and discussions are illustrated in Section VI. Some conclusions are given in Section VII.

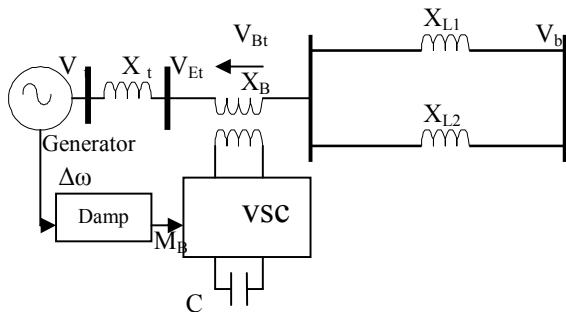

Fig. 1 (a) SSSC based damping controller

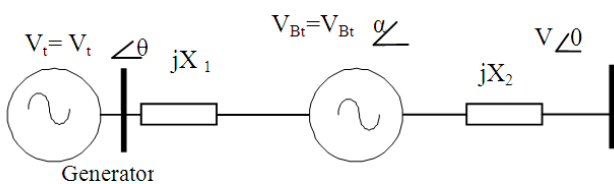

Fig. 1 (b) Equivalent Circuit

II. DESCRIPTION OF STUDIED SYSTEM

Fig. 1 shows a third order nonlinear mathematical voltage source converter (VSC) based series connected SSSC. Fig. 1 (b) is the equivalent circuit of the system. The transformer leakage reactance is represented by reactance X_1 , whereas equivalent reactance of the parallel lines is represented by

reactance X_2 which also includes the leakage reactance of the series booster transformer if required. The SSSC voltage V_{Bt} changes the magnitude of the current for a given V_t and V , and not its angle. The resistances of all the components of the system like transformer, transmission lines, series converter transformer and generator) and transients of the transmission lines are neglected while deriving the algebraic equations. The algebraic equations are as follows:

$$P_e = V_{td}I_d + V_{tq}I_q \quad (1)$$

$$V_{tq} = E'_q + V_{tq}I_q \quad (2)$$

$$V_{td} = X_q I_q \quad (3)$$

$$E_q = E'_q + (X_d - X'_d)I_d \quad (4)$$

$$V_{td} + jV_{tq} = X_q I_q + j(E'_q - X'_d I_d) = jX_t(I_d + jI_q) + V_{Btd} + jV_{Btq} + jV_{bq} + V_{bq} \quad (5)$$

$$V_{Btd} = \frac{M_b V_{dc} \cos \delta_B}{2} \quad (6)$$

$$V_{Btq} = \frac{M_b V_{dc} \sin \delta_B}{2} \quad (7)$$

$$V_{bd} = V_b \sin \delta \quad (8)$$

$$V_{bq} = V_b \cos \delta \quad (9)$$

$$X_3 = X_q + X_t + X_L \quad (10)$$

$$X_4 = X'_d + X_t + X_L \quad (11)$$

The non-linear dynamic model of the system using SSSC is given below. The static excitation system, model type IEEE ST1A, has been considered [1]. The SSSC is assumed to be based on pulse width modulation (PWM) converters.

A. Non-Linear Dynamic Model

$$\dot{\delta} = \omega_0 \omega \quad (12)$$

$$\dot{\omega} = \frac{(P_m - P_e - D\omega)}{M} \quad (13)$$

$$\dot{E}'_q = \frac{(E_{fd} - E_q)}{T'_{do}} \quad (14)$$

B. Linear Dynamic Model

By linearising the non-linear model around an operating condition, a linear dynamic model is obtained [18], [19]. The linearised model is described below.

$$\Delta \dot{\delta} = \omega_0 \Delta \omega \quad (15)$$

$$\Delta \dot{\omega} = \frac{(\Delta P_e - D \Delta \omega)}{M} \quad (16)$$

$$\Delta \dot{E}'_q = \frac{(\Delta E_{fd} - \Delta E_q)}{T'_{do}} \quad (17)$$

$$\Delta \dot{E}'_{fd} = -\frac{\Delta E_{fd}}{T_A} - \frac{K_A \Delta V_t}{T_A} \quad (18)$$

$$\Delta P_e = K_1 \Delta \delta + K_2 \Delta E'_q + K_{p1} \Delta V_{dc} + K_{p2} \Delta M_B + K_{p3} \Delta \delta_B \quad (19)$$

$$\Delta E_q = K_3 \Delta \delta + K_4 \Delta E'_q + K_{E1} \Delta V_{dc} + K_{E2} \Delta M_B + K_{E3} \Delta \delta_B \quad (20)$$

$$\Delta V_t = K_5 \Delta \delta + K_6 \Delta E'_q + K_{v1} \Delta V_{dc} + K_{v2} \Delta M_B + K_{v3} \Delta \delta_B \quad (21)$$

$$\Delta V_{dc} = K_7 \Delta \delta + K_8 \Delta E'_q - K_9 \Delta V_{dc} + K_{vd2} \Delta M_B + K_{vd3} \Delta \delta_B \quad (22)$$

III. SSSC BASED DAMPING CONTROLLER

The damping controller is provided to improve the damping of power system oscillations. The input to the damping controller is the speed-deviation signal [20], [21] and the output signal is the injected voltage V_q . The damping controllers are designed with a purpose to produce an electrical torque in phase with the speed deviation.

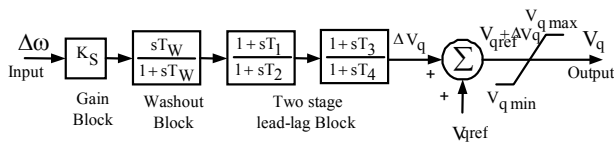

Fig. 2 Lead-lag structure of SSSC-based controller

Fig. 2 shows the damping controller that consists of gain, signal wash-out and phase compensator blocks. The parameters of the damping controller are obtained using the GSA technique. In this paper, Gravitational Search Algorithm is proposed for the optimal computation of phase compensator block parameters. The phase compensation blocks time constants (T_1 , T_2 , T_3 and T_4) provide the appropriate phase-lead characteristics to compensate for the phase lag between input and the output signals. The desired value of compensation is obtained according to the change in the SSSC injected voltage ΔV_q which is added to V_{ref} .

IV. GRAVITATIONAL SEARCH ALGORITHM

Rashedi, Hossein and Saryazdi [14], first introduced Gravitational Search Algorithm in 2009 as a new heuristic method. The original intention of their research was to graphically model the Newton's gravitational law and laws of motion. The basic physical theory from which GSA is inspired is Newton theory, which says: 'Every particle in the universe attracts every other particle with a force that is directly proportional to the product of their masses and inversely proportional to the square of the distance between them'. GSA can be considered as a collection of agents (candidate solutions) which have masses proportional to their value of fitness function. During generations all masses attract each other by the gravity forces between them. The heavier the mass, the bigger the attraction force is. Therefore, the heaviest masses which are probably close to the global minimum attract the other masses in proportion to their distances.

According to [14], [15], suppose there is a system with N agents. The position of each agent (masses) which is a candidate solution for the problem is defined as follows;

$$X_i = (X_i^1, \dots, X_i^d, \dots, X_i^N)$$

$$\text{for } i = 1, 2, \dots, N \quad (23)$$

where N is the dimension of the problem and x_i^d is the position of the i th agent in the d th dimension.

The algorithm starts by randomly placing all agents in a search space. During all epochs, the gravitational forces from agent j on agent i at a specific time t is defined as follows:

$$F_{ij}^d(t) = G(t) \frac{M_{pi}(t) \times M_{aj}(t)}{R_{ij}(t) + \epsilon} (x_j^d(t) - x_i^d(t)) \quad (24)$$

where M_{aj} is the active gravitational mass related to agent j , M_{pi} is the passive gravitational mass related to agent i , $G(t)$ is the gravitational constant at time $t \in \mathbb{R}$ is small constant $R_{ij}(t)$ is the Euclidian distance between two agents i and j .

The gravitational constant G and the Euclidian distance between two agents i and j are calculated as follows:

$$G(t) = G_0 e^{-\alpha t/T} \quad (25)$$

$$R_{ij}(t) = \|x_i(t) - x_j(t)\|_2 \quad (26)$$

where α is the descending coefficient, G_0 is the initial gravitational constant, t is the current iteration, and T is the maximum number of iterations.

In a problem space with the dimension d , the total force that acts on agent i is calculated by the following equation:

$$F_i^d(t) = \sum_{j=1, j \neq i}^N rand_j F_{ij}^d(t) \quad (27)$$

where $rand_j$ is a random number in the interval $[0,1]$. According to the law of motion, the acceleration of an agent is proportional to the resultant force and inverse of its mass, so the accelerations of all agents are calculated as follows:

$$a_i^d(t) = \frac{F_i^d(t)}{M_{ii}(t)} \quad (28)$$

where d is the dimension of the problem, t is a specific time, and M_i is the mass of object i . The velocity and position of agents are calculated as follows:

$$V_i^d(t+1) = rand_i^* v_i^d(t) + a_i^d(t) \quad (29)$$

$$X_i^d(t+1) = x_i^d(t) + v_i^d(t+1) \quad (30)$$

where d is the problem dimension and $rand_j$ is a random number in the interval $[0, 1]$.

As can be inferred from (29) and (30), the current velocity of an agent is defined as a fraction of its last velocity ($0 \leq rand_i \leq 1$) added to its acceleration. Furthermore, the current position of an agent is equal to its last position added to its current velocity. Agents' masses are defined using fitness evaluation. This means that an agent with the heaviest mass is the most efficient agent. According to the above equations, the heavier the agent, the higher the attraction force and the

slower the movement are. The higher attraction is based on the law of gravity, and the slower movement is because of the law of motion [14].

The masses of all agents are updated using the following equations

$$m_i(t) = \frac{fit_i(t) - worst(t)}{best(t) - worst(t)} \quad (31)$$

where $fit_i(t)$ represents the fitness value of the agent i at time t , $best(t)$ is the strongest agent at time t , and $worst(t)$ is the weakest agent at time t , $best(t)$ and $worst(t)$ for a minimization problem are calculated as follows:

$$best(t) = \min_{j \in \{1..N\}} fit_j(t) \quad (32)$$

$$worst(t) = \max_{j \in \{1..N\}} fit_j(t) \quad (33)$$

$best(t)$ and $worst(t)$ for a maximization problem are calculated as follows:

$$best(t) = \max_{j \in \{1..N\}} fit_j(t) \quad (34)$$

$$worst(t) = \min_{j \in \{1..N\}} fit_j(t) \quad (35)$$

The normalization of the calculated masses (9) is defined by the following equation:

$$M_i(t) = \frac{m_i(t)}{\sum_{j=1}^N m_j(t)} \quad (36)$$

In the GSA, at first all agents are initialized with random values. Each agent is a candidate solution. After initialization, the velocity and position of all agents will be defined using (29) and (30). Meanwhile, other parameters such as the gravitational constant and masses will be calculated by (25) and (31). Finally, the GSA will be stopped by meeting an end criterion. The steps of GSA are represented in Fig. 3. In all population-based algorithms which have social behavior like GSA, should be considered: the ability of the algorithm to explore whole parts of search spaces and its ability to exploit the best solution. Searching through the whole problem space is called exploration whereas converging to the best solution near a good solution is called exploitation. A population-based algorithm should have these two vital characteristics to guarantee finding the best solution. In GSA, by choosing proper values for the random parameters (G_0 and α), the exploration can be guaranteed and slow movement of heavier agents can guarantee the exploitation ability [14], [16].

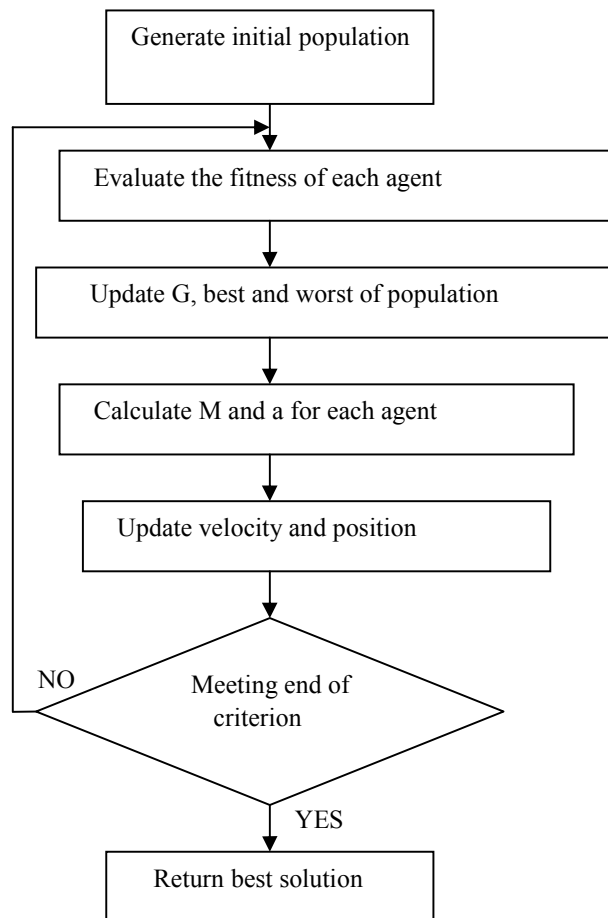

Fig. 3 General principle of GSA

V. SSSC CONTROLLER DESIGN USING GSA

In the proposed method, the SSSC controller parameters must be tuned optimally to improve overall system dynamic stability in a robust way. The parameters of the SSSC damping controller are tuned for different loading conditions.

TABLE I
 SSSC CONTROLLER PARAMETERS

Operating conditions	$P(p.u)$	δ_0
Nominal	Pe= 0.75p.u	45.3°
Light	Pe= 0.4p.u	22.91°
Heavy	Pe= 1p.u	60.7°

For our optimization problem, an integral time absolute error of the speed deviations is taken as the objective function J expressed as:

$$J = \int_0^{t_1} |\Delta\omega(t)| t . dt \quad (37)$$

In the above equations, $\Delta\omega(t)$ denotes the rotor speed deviation for a set of controller parameters i.e. the parameters of the SSSC controller and t_1 is the time range of the simulation. The optimization problem design can be formulated as the constrained problem shown below, where the constraints are the controller parameters bounds.

Minimize J
 Subject to

$$\begin{aligned} K_{\min} &\leq K \leq K_{\max} \\ T_{1\min} &\leq T_1 \leq T_{1\max} \\ T_{2\min} &\leq T_2 \leq T_{2\max} \\ T_{3\min} &\leq T_3 \leq T_{3\max} \\ T_{4\min} &\leq T_4 \leq T_{4\max} \end{aligned} \quad (38)$$

Typical ranges of the optimized parameters are [0, 100] for K and [0.01, 1] for T_1 , T_2 , T_3 , and T_4 . The mentioned approach employs the GSA to solve this optimization problem and searches for an optimal or near-optimal set of controller parameters. It should be noted that GSA algorithm is run several times and then optimal set of output feedback gains for the SSSC controllers is selected. The final values of the optimized parameters are given in Table II.

TABLE II

GSA OPTIMIZED SSSC BASED DAMPING CONTROLLER PARAMETERS					
Controller	Gain	T _{issc1}	T _{issc2}	T _{dssc1}	T _{dssc2}
SSSC	69.0026	0.6871	0.4416	0.6771	0.6423

VI. SIMULATION RESULTS

In order to demonstrate the effectiveness and robustness of the proposed controller, a 3-cycle 3-phase fault at $t = 1$ s, on the infinite bus has occurred, at all loading conditions as described in Table I. The speed deviation and electrical power deviation based on the SSSC based controller in three different loading conditions are shown in Figs. 4-7. It can be observed that the GSA based SSSC controller tuned using the objective function achieves good robust performance and provides superior damping in power system. Each figure contains two plots as: **Solid (black)**: stabilizer with GSA approach **Solid (red)**: without stabilizer. It is evident from these figures that the system without stabilizer contains insufficient damping and the responses are pendulous. But the proposed GSA based stabilizer can greatly enhance power system stability and damp out the oscillations effectively.

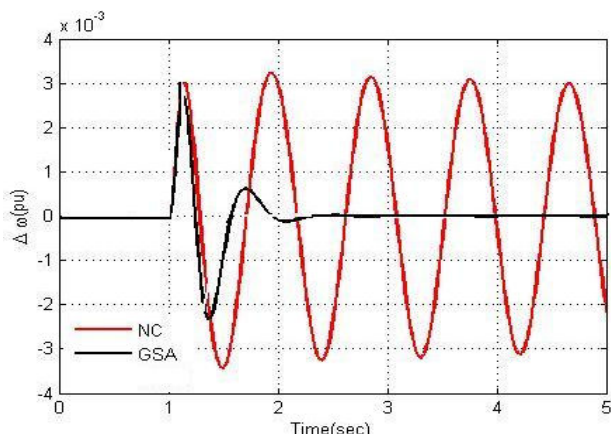

Fig. 4 Speed deviation response for a 3-cycle, 3-phase fault disturbance at middle of transmission line cleared by 3-cycle line tripping at nominal loading

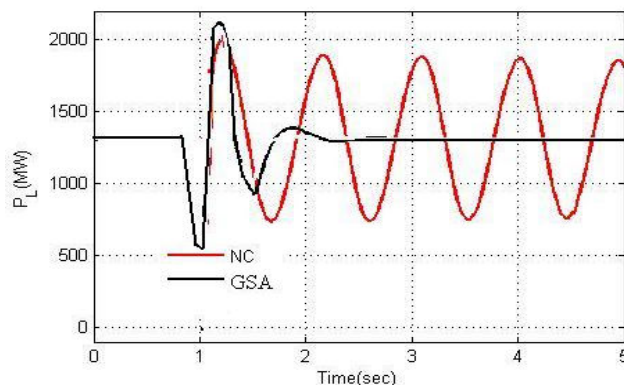

Fig. 5 Line Power flow

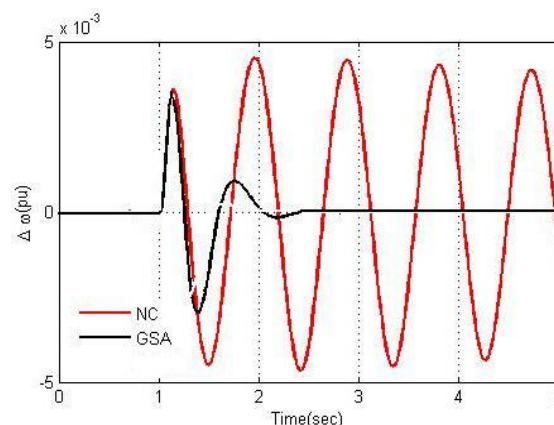

Fig. 6 System response for a 3-cycle, 3-phase fault at bus 1 Light loading

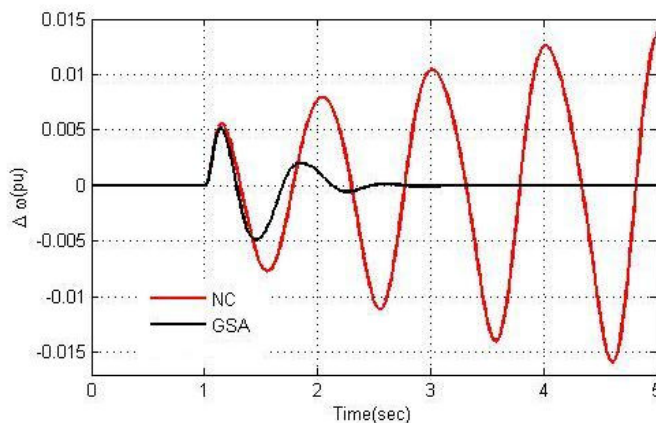

Fig. 7 System response for a three-cycle fault at bus 3 at heavy loading

To test the robustness of the controller, the generator loading is changed to light loading and the effectiveness of the proposed controller for unbalanced fault is also examined by applying different types of unsymmetrical faults namely; single line to ground fault (L-G), double line to ground fault (L-L-G), double line to line fault (L-L). The speed deviation based on the SSSC based controller in these fault conditions are shown in Figs. 8-10. It is observed from these figures that

the proposed GSA approach is a superior optimized technique with SSSC- based controller as the system is stabilized quickly.

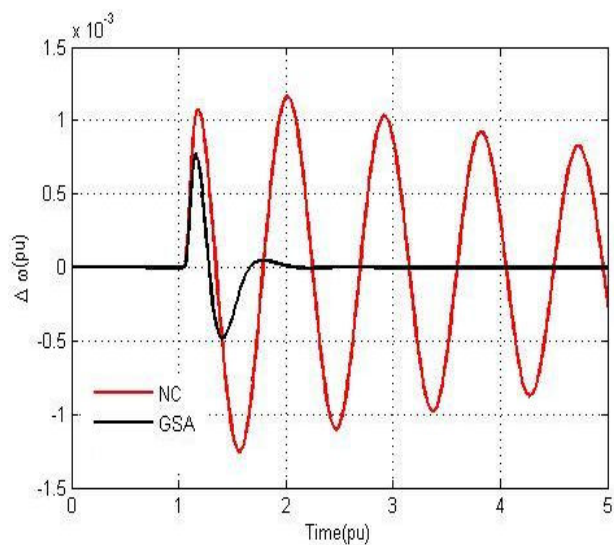

Fig. 8 System response for a three-cycle, unbalance fault (L-G) at bus 3 at Light loading

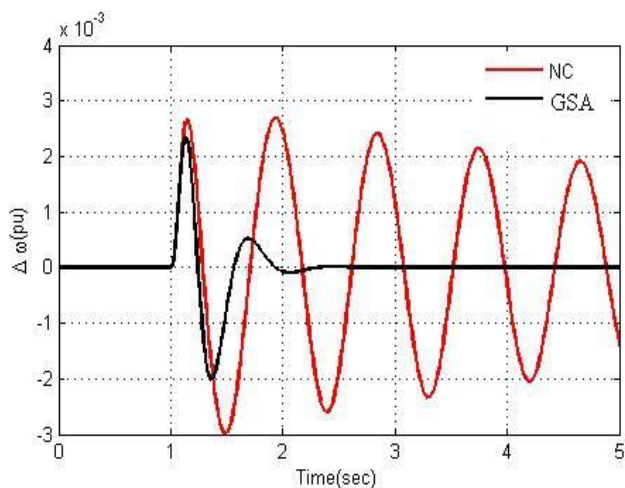

Fig. 9 System response for a 3-cycle, unbalance fault (L-L-G) at bus 3 at Light loading

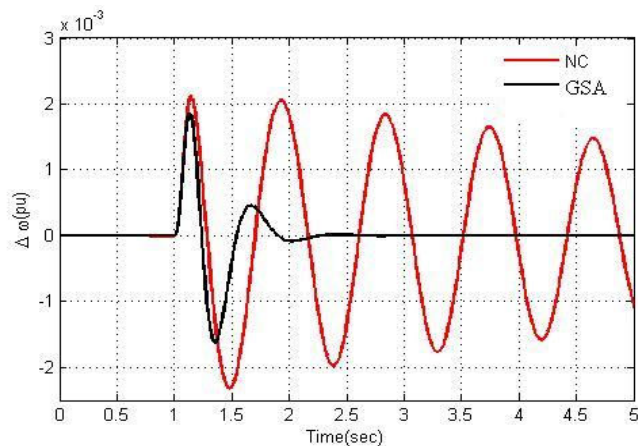

Fig. 10 System response for a 3-cycle, unbalance fault (L-L) at bus 3 at Light loading

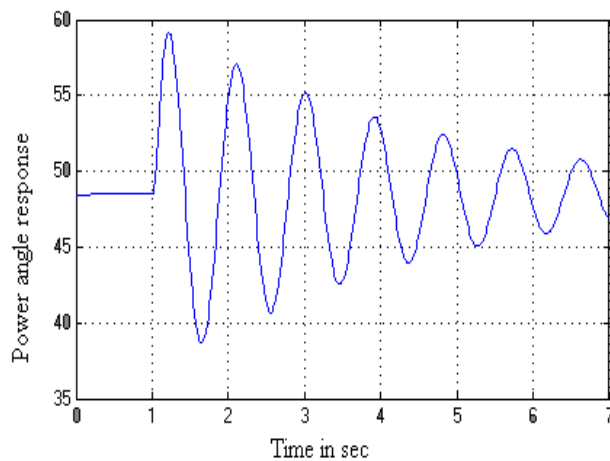

Fig. 11 Power angle response without SSSC Controller

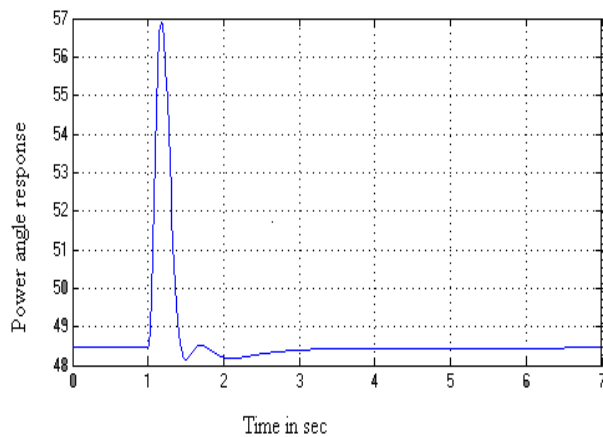

Fig. 12 Power angle response with SSSC Controller

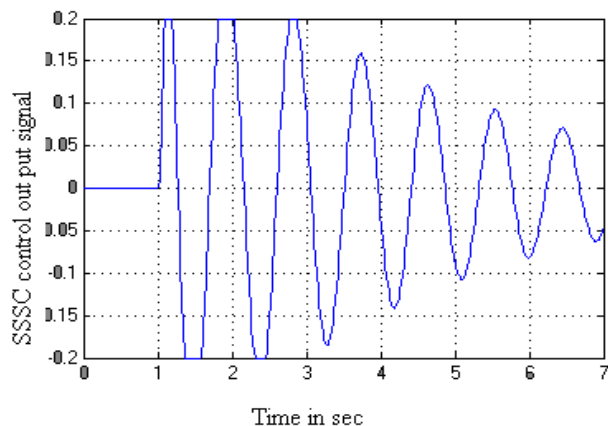

Fig. 13 SSSC output signal without controller

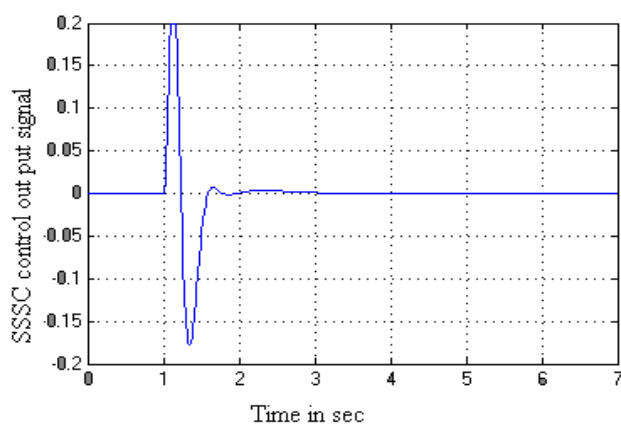

Fig. 14 SSSC output signal with controller

The power angle response without and with SSSC based controller (GSA approach) is shown in Figs. 11 and 12 respectively. The SSSC-injected voltage is shown in Figs. 13 and 14 respectively from which it is clear that the injected voltage is suitably modulated to damp the power system oscillations.

VII. CONCLUSION

The results obtained showed that in a single-machine system, SSSC based damping controllers can be tuned to provide satisfactory damping performance over a set of operating conditions. The GSA-based tuning process has produced robust controllers, satisfying the design criteria in a large-scale realistic power system. The results show that the power system oscillations are damped out very quickly with the help of SSSC based damping controllers in few seconds. The performance of proposed controller has been investigated under various disturbances and loadings. It is concluded from these results that the use of SSSC is having improved dynamic response and at the same time faster than other conventional controllers. The gravitational search algorithm has been proposed to capture its near global solution. Moreover, this approach is also simple and easy to be realized in power systems.

APPENDIX

TABLE III

DATA OF THREE MACHINE NINE BUS POWER SYSTEM WITH SSSC

Generators	$S_{B1}=4200\text{ MVA}, S_{B2}=S_{B3}=2100\text{ MVA},$ $H=3.7\text{ s}, V_B=13.8\text{ kV}, f=60\text{ Hz}, P_{co}=0.75,$ $V_{fo}=1.0, R_S=2.8544\text{ e}^{-3}, X_d=1.305, X_d'=0.296, X_d''=$ $.252, X_q=0.474, X_q'=0.18, T_d=1.01\text{ s}, T_d'$ $=0.053\text{ s}, T_{qo}=0.1\text{ s}$
Hydraulic Turbine and Governor	$K_a=3.33, T_a=0.07, G_{min}=0.01, G_{max}=0.97518, V_{gmin}=-$ $0.1\text{ pu/s}, V_{gmax}=0.1\text{ pu/s}, R_p=0.05, K_p=1.163, K_i$ $=0.105, K_d=0, T_d=0.01\text{ s}, \beta=0, T_w=2.67\text{ s}$
Excitation System	$T_{LP}=0.02\text{ s}, K_a=200, T_a=0.001\text{ s}, K_e=1,$ $T_e=0, T_b=0, T_c=0, K_f=0.001, T_f=0.1\text{ s},$ $E_{fmin}=0, E_{fmax}=7, K_p=0$
Transformers	$S_{BT1}=4200\text{ MVA}, S_{BT2}=S_{BT3}=2100\text{ MVA}, 13.8/500\text{ kV}, 60$ $\text{ Hz}, R_1=R_2=0.002, L_1=L_2=0, D_1/Y_c\text{ connection}, R_m=$ $500, L_m=500$
Transmission Line	$3\text{-Ph}, L_1=175\text{ km}, L_2=50\text{ km}, L_3=100\text{ km}, R_1$ $=0.02546\ \Omega/\text{ km}, R_0=0.3864\ \Omega/\text{ km},$ $L_1=0.9337\text{ e}^{-3}\text{ H/km}, L_0=4.1264\text{ e}^{-3}\text{ H/km}, C_1$ $=12.74\text{ e}^{-9}\text{ F/km}, C_0=7.751\text{ e}^{-9}\text{ F/km}$
SSSC	$S_{nom}=100\text{ MVA}, V_{nom}=500\text{ kV}, f=60\text{ Hz}, V_{qmax}=0.2,$ $\text{Max rate of change of } V_{qref}=3/\text{ s}, V_{DC}=40\text{ kV}, C_{DC}=$ $375\text{ e}^{-6}\text{ F}, K_p=0.00375, K_i=0.1875, V_q=\pm 0.2\text{ pu}, K_{p_vdcR}$ $=0.1\text{ e}^{-3}, K_{i_vdcR}=20\text{ e}^{-3}$

REFERENCES

- [1] P.M. Anderson and A.A. Fouad, "Power system control and stability," IEEE Press, 1993.
- [2] O. I. Elgerd, "Electric energy system Theory," An Introduction. McGraw-Hill, 1982.
- [3] P. Kundur, "1994. Power System Stability and Control," New York, McGraw-Hill.
- [4] N.G. Hingorani and L. Gyugyi, "Understanding FACTS: concepts and technology of flexible ac transmission systems," IEEE Press, NY. 1999.
- [5] L. Gyugyi, "solid state control of electric power in ac transmission system," int.symp.elect.energy conv.in power syst.invited paper no.tip-4, 1989.
- [6] L. Gyugyi, "Dynamic compensation of ac transmission lines by solid-state synchronous voltage sources," IEEE Trans. Power Deliv. 9 (1994) 904-911.
- [7] L. Gyugyi, C.D. Schauder and K.K. Sen, "Static synchronous series compensator: a solid state approach to the series compensation of transmission lines," IEEE Trans. Power Deliv. 12 (1997) 406-417.
- [8] K.K. Sen, "SSSC-static synchronous series compensator: theory, modeling, and applications," IEEE Trans. Power Deliv. 13 (1998) 241-246.
- [9] S. Panda and N.P. Padhy, "Comparison of particle swarm optimization and genetic algorithm for FACTS-based controller design," Appl. Soft Comput. 8 (4) (2008) 1418-1427.
- [10] S. Panda, N.P. Padhy and R.N. Patel, "Power system stability improvement by PSO optimized SSSC-based damping controller," Electr. Power Comp. Syst. 36 (5) (2008) 468-490.
- [11] S. Panda, "Differential evolutionary algorithm for TCSC-based controller design," Simulat. Model. Pract. Theory 17 (2009) 1618-1634.
- [12] D. E. Goldberg, "Genetic algorithms in search, optimization, and machine learning," New York: Addison-Wesley.
- [13] S. Panda, "Multi-objective evolutionary algorithm for SSSC-based controller design," Electr. Power Syst. Res. 79 (6) (2009) 937-944.
- [14] E. Rashedi, S. Nezamabadi and S. Saryazdi, "GSA: a gravitational search algorithm," Information Sciences, vol. 179, no. 13, pp. 2232-2248, 2009.
- [15] A. Atapour, A. Ghanizadeh and S.M. Shamsuddin, "Advances of Soft Computing Methods in Edge Detection," International Center for Scientific Research and Studies, vol. 1. no. 2, pp 162-202, 2009.
- [16] E. Rashedi, H. Nezamabadi-pou and S. Saryazdi, "BGSA: binary gravitational search algorithm," Natural Computing vol. 9, no. 3, pp. 727-745, 2009.
- [17] S. Sinaie, "Solving shortest path problem using Gravitational Search Algorithm and Neural Networks," University Teknologi Malaysia (UTM), Joho r Bahru, Malaysia, M.Sc. Thesis 2010.

- [18] Xiaoqing Han, Nahnan Tian and Zhijing Zheng, "Small-Signal Stability Analysis on Power system considering Load Characteristics," Power and Energy Engineering Conference, APPEEC, Asia-Pacific, 2009, pp.1-4.
- [19] John M. Undril, "Dynamic Stability Calculations for an Arbitrary Number of Interconnected Synchronous Machines," IEEE Trans. On Power Apparatus and Systems, Vol. PAS-87, No. 3, March 1968, pp.835-844.
- [20] H.F.Wang, "Damping function of unified power flow controller," IEE Proc. Gener. Transm. Distrib, Vol. 146, No. 1, January 1999, pp. 81-87.
- [21] N.Tamby and M.L.Kothari, "Damping of power system oscillations with unified power flow controller (UPFC)," IEE Proc. Gener. Transm. Distrib, Vol. 150, No. 2, March 2003, pp. 129-140.

Gayadhar Panda was born in Odisha, India, in 1970. He received B.E. degree in electrical engineering from the Institution of engineers (I), the M.E degree in electrical engineering from Bengal Engineering College, Shibpur, Howrah, India and the Ph.D. degree in electrical engineering from Utkal University in 1996, 1998 and 2007 respectively. He is currently working as Associate Professor in the Deptt. of Electrical & Electronics Engineering, NIT, Meghalaya, India. His research interests are in the areas of stability aspects of power transmission, power electronics and development of renewable energy.

P.K. Rautraya was born in Odisha, India in 1970. He received the B.E. degree in electrical Engineering from Utkal University, Odisha, India, in 1993 and M.Tech degree from the Department of Electrical Engineering, SOA University, Odisha, India in 2009. He is currently working as a Lecturer at Govt. College of Engineering, Kalahandi, Bhawanipatna, Odisha, India. His current area of research in power system and power electronics and drives.